



# Vehicle History Report™

US \$44.99

## 2022 KIA EV6 WIND

VIN: KNDC34LA4N5044738  
 4 DOOR WAGON/SPORT  
 UTILITY  
 ELECTRIC  
 REAR WHEEL DRIVE  
 Original Window Sticker

### Damage reported: minor damage

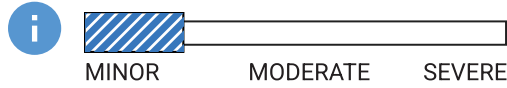

17 Service history records

At least 1 open recall

2 Previous owners

115,755 Last reported odometer reading



This CARFAX Vehicle History Report is based only on information supplied to CARFAX and available as of 7/28/25 at 2:49:17 PM (CDT). Other information about this vehicle, including problems, may not have been reported to CARFAX. Use this report as one important tool, along with a vehicle inspection and test drive, to make a better decision about your next used car.



## Accident / Damage History

Not all accidents / issues are reported to CARFAX

### Event 1

08/08/2023

**Damage reported: minor damage**

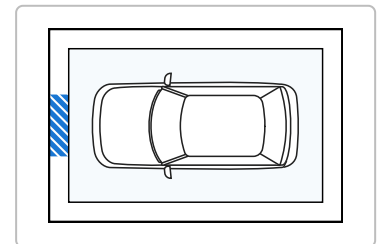
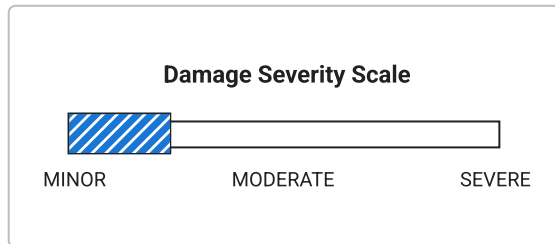



## Additional History

Not all accidents / issues are reported to CARFAX



	Owner 1	Owner 2
<b>Total Loss</b> No total loss reported to CARFAX.	No Issues Reported	No Issues Reported
<b>Structural Damage</b> CARFAX recommends that you have this vehicle inspected by a collision repair specialist.	No Issues Reported	No Issues Reported

<b>Airbag Deployment</b> No airbag deployment reported to CARFAX.	<input checked="" type="checkbox"/> No Issues Reported	<input checked="" type="checkbox"/> No Issues Reported
<b>Odometer Check</b> No indication of an odometer rollback.	<input checked="" type="checkbox"/> No Issues Indicated	<input checked="" type="checkbox"/> No Issues Indicated
<b>Accident / Damage</b> Damage reported: 08/08/2023.	<input checked="" type="checkbox"/> No Issues Reported	Minor Damage
<b>Manufacturer Recall</b> At least 1 open recall reported.	<input checked="" type="checkbox"/> No Recalls Reported	Recall Reported
<b>Basic Warranty</b> Original warranty estimated to have expired.	<b>Warranty Expired</b>	<b>Warranty Expired</b>

 <b>Title History</b> CARFAX guarantees the information in this section	Owner 1	Owner 2
<b>Damage Brands</b> Salvage   Junk   Rebuilt   Fire   Flood   Hail   Lemon	<input checked="" type="checkbox"/> <b>Guaranteed</b> No Problem	<input checked="" type="checkbox"/> <b>Guaranteed</b> No Problem
<b>Odometer Brands</b> Not Actual Mileage   Exceeds Mechanical Limits	<input checked="" type="checkbox"/> <b>Guaranteed</b> No Problem	<input checked="" type="checkbox"/> <b>Guaranteed</b> No Problem
 <b>GUARANTEED</b> - None of these title problems were reported by a U.S. state Department of Motor Vehicles (DMV). If you find that any of these title problems were reported by a DMV and not included in this report, you may qualify. <a href="#">View Terms</a>   <a href="#">View Certificate</a>		

 <b>Ownership History</b> The number of owners is estimated	Owner 1	Owner 2
Year purchased	2022	2023
Type of owner	Personal	Personal
Estimated length of ownership	7 months	1 yr. 11 mo.
Owned in the following states/provinces	Florida	Georgia, Virginia
Estimated miles driven per year	---	46,698/yr
Last reported odometer reading	24,039	115,755

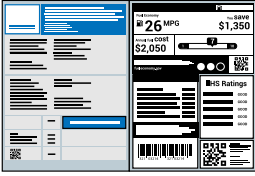
 <b>Detailed History</b>
 <b>Owner 1</b> Purchased: 2022 <span style="float: right;">Personal Vehicle</span>

Date	Mileage	Source	Comments
Not Reported		Kia Motors America, Inc.	<b>Original Window Sticker</b> 
04/28/2022	7	Dealer Inventory	<b>Vehicle offered for sale</b>
05/20/2022		Bill Byrd Kia Panama City, FL 850-610-1450 billbyrdkiapanamacity.com/	<b>Vehicle sold</b>
		★ 4.6 / 5.0 811 Verified Reviews ❤️ 4,791 Customer Favorites	
05/20/2022	104	Florida Motor Vehicle Dept. Lynn Haven, FL	<b>Vehicle purchase reported</b> - Title issued or updated - Registration issued or renewed - First owner reported - Titled or registered as personal vehicle - Loan or lien reported - Vehicle color noted as Gray
07/20/2022	8,106	Bill Byrd Kia Panama City, FL 850-610-1450 billbyrdkiapanamacity.com/	 <b>Vehicle serviced</b> - Maintenance inspection completed - Tire condition and pressure checked - Tires rotated
		★ 4.6 / 5.0 811 Verified Reviews ❤️ 4,791 Customer Favorites	
09/15/2022	15,553	Bill Byrd Kia Panama City, FL 850-610-1450 billbyrdkiapanamacity.com/	 <b>Vehicle serviced</b> - Maintenance inspection completed - Interior cleaned
		★ 4.6 / 5.0 811 Verified Reviews ❤️ 4,791 Customer Favorites	
09/19/2022		Florida Motor Vehicle Dept. Lynn Haven, FL	<b>Registration issued or renewed</b> - Titled or registered as personal vehicle - Loan or lien reported - Vehicle color noted as Gray

01/02/2023	24,039	ALM KIA South Union City, GA 678-783-2500 almsouth.com/used-cars.aspx		<b>Vehicle serviced</b> - Maintenance inspection completed
		★ <b>3.9 / 5.0</b> 607 Verified Reviews ❤️ <b>10,569</b> Customer Favorites		
01/10/2023	Florida Motor Vehicle Dept. Newnan, GA		<b>Registration issued or renewed</b> - Titled or registered as personal vehicle - Loan or lien reported - Registration updated when owner moved the vehicle to a new location - Vehicle color noted as Gray	

	<b>Owner 2</b> Purchased: 2023	Personal Vehicle 46,698 mi/yr
--	-----------------------------------	----------------------------------

Date	Mileage	Source	Comments
01/18/2023		Georgia Motor Vehicle Dept.	<b>Vehicle purchase reported</b>
01/23/2023		Georgia Motor Vehicle Dept. Newnan, GA	<b>Title issued or updated</b> - Title or registration issued - New owner reported - Loan or lien reported - Vehicle color noted as Gray
02/22/2023	31,457	Kia of LaGrange Lagrange, GA 706-298-5024 kiaoflagrange.com	<b>Vehicle serviced</b> - Maintenance inspection completed - Tires rotated
		★ <b>4.8 / 5.0</b> 834 Verified Reviews ❤️ <b>7,129</b> Customer Favorites	
03/22/2023	34,611	Kia of LaGrange Lagrange, GA 706-298-5024 kiaoflagrange.com	<b>Vehicle serviced</b> - Maintenance inspection completed - Alignment checked - Four tires replaced
		★ <b>4.8 / 5.0</b> 834 Verified Reviews ❤️ <b>7,129</b> Customer Favorites	
05/09/2023	39,284	Kia of LaGrange Lagrange, GA 706-298-5024 kiaoflagrange.com	<b>Vehicle serviced</b> - Maintenance inspection completed - Cabin air filter replaced/cleaned - Tires rotated
		★ <b>4.8 / 5.0</b>	

834 Verified Reviews  
♥ 7,129 Customer Favorites

06/06/2023 41,000

ALM KIA South  
Union City, GA  
678-783-2500  
almsouth.com/used-cars.aspx

★ 3.9 / 5.0

607 Verified Reviews  
♥ 10,569 Customer Favorites



**Vehicle serviced**

- One tire balanced
- One tire mounted
- One tire replaced
- Tire(s) mounted
- Vehicle washed/detailed

07/07/2023 45,337

Kia of LaGrange  
Lagrange, GA  
706-298-5024  
kiaoflagrange.com

★ 4.8 / 5.0

834 Verified Reviews  
♥ 7,129 Customer Favorites



**Vehicle serviced**

- Maintenance inspection completed
- Tires rotated

08/03/2023 48,387

Kia of LaGrange  
Lagrange, GA  
706-298-5024  
kiaoflagrange.com

★ 4.8 / 5.0

834 Verified Reviews  
♥ 7,129 Customer Favorites



**Vehicle serviced**

- Maintenance inspection completed
- Brake fluid flushed/changed

08/08/2023

**Damage Report**



**Damage reported: minor damage**

- Damage to front

**Damage Severity Scale**

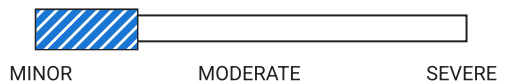

**Damage Location**

FRONT

LEFT



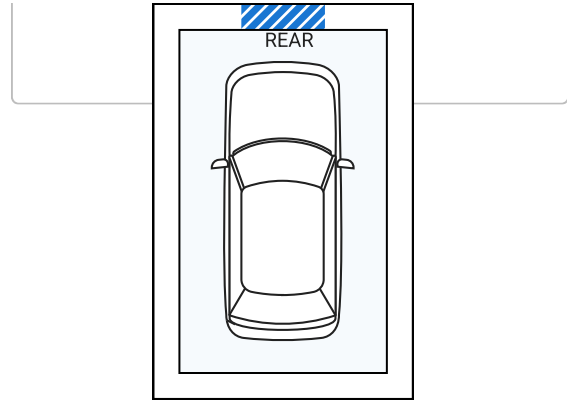







RIGHT



Minor damage is usually cosmetic, including dents or scratches to the vehicle body.

08/25/2023	51,399	Kia of LaGrange Lagrange, GA 706-298-5024 kiaoflagrange.com		<b>Vehicle serviced</b> - Maintenance inspection completed - Tires rotated
		★ 4.8 / 5.0 834 Verified Reviews ♥ 7,129 Customer Favorites		
09/20/2023	Georgia Motor Vehicle Dept. Newnan, GA		<b>Registration issued or renewed</b> - Loan or lien reported - Vehicle color noted as Gray	
09/29/2023	56,694	Kia of LaGrange Lagrange, GA 706-298-5024 kiaoflagrange.com		<b>Vehicle serviced</b> - Maintenance inspection completed - Tires rotated
		★ 4.8 / 5.0 834 Verified Reviews ♥ 7,129 Customer Favorites		
11/24/2023	63,041	Valvoline Instant Oil Change Newnan, GA 770-304-0039 vioc.com		<b>Vehicle serviced</b> - Tires rotated
		★ 4.8 / 5.0 284 Verified Reviews		

 **178** Customer Favorites

01/03/2024	69,390	Valvoline Instant Oil Change Newnan, GA 770-304-0039 vioc.com  ★ <b>4.8 / 5.0</b> 284 Verified Reviews  <b>178</b> Customer Favorites	 <b>Vehicle serviced</b> - Tires rotated
01/16/2024	71,602	Kia of LaGrange Lagrange, GA 706-298-5024 kiaoflagrange.com  ★ <b>4.8 / 5.0</b> 834 Verified Reviews  <b>7,129</b> Customer Favorites	 <b>Vehicle serviced</b> - Maintenance inspection completed - Tire repaired
04/29/2024	73,857	Kia of LaGrange Lagrange, GA 706-298-5024 kiaoflagrange.com  ★ <b>4.8 / 5.0</b> 834 Verified Reviews  <b>7,129</b> Customer Favorites	 <b>Vehicle serviced</b> - Maintenance inspection completed - Tire condition and pressure checked
05/27/2024	90,162	Kia of LaGrange Lagrange, GA 706-298-5024 kiaoflagrange.com  ★ <b>4.8 / 5.0</b> 834 Verified Reviews  <b>7,129</b> Customer Favorites	 <b>Vehicle serviced</b> - Maintenance inspection completed
06/20/2024	93,381	Kia of LaGrange Lagrange, GA 706-298-5024 kiaoflagrange.com  ★ <b>4.8 / 5.0</b> 834 Verified Reviews  <b>7,129</b> Customer Favorites	 <b>Vehicle serviced</b> - Maintenance inspection completed
10/17/2024		Georgia Motor Vehicle Dept. Newnan, GA	<b>Registration issued or renewed</b> - Loan or lien reported - Vehicle color noted as Gray
11/18/2024		Kia Motors America, Inc.	<b>Manufacturer Safety Recall issued</b> - NHTSA #24V867

- Recall #SC327 ICCU INSPECTION/REPLACEMENT & S/W UPDATE
- Status: Remedy Available

Locate an authorized Kia dealer near you to schedule an appointment

[Learn more about this recall](#)

**Description:** KIA AMERICA, INC. IS RECALLING CERTAIN 2022-2024 EV6 VEHICLES. THE INTEGRATED CHARGING CONTROL UNIT (ICCU) MAY BECOME DAMAGED AND STOP CHARGING THE 12-VOLT BATTERY, WHICH CAN RESULT IN A LOSS OF DRIVE POWER.

A LOSS OF DRIVE POWER INCREASES THE RISK OF A CRASH.

**Remedy:** DEALERS WILL INSPECT AND REPLACE THE ICCU AND ITS FUSE, AS NECESSARY. IN ADDITION, DEALERS WILL UPDATE THE ICCU SOFTWARE. ALL REPAIRS WILL BE PERFORMED FREE OF CHARGE. OWNER NOTIFICATION LETTERS WERE MAILED DECEMBER 13, 2024. OWNERS MAY CONTACT KIA CUSTOMER SERVICE AT 1-800-333-4542. KIA'S NUMBER FOR THIS RECALL IS SC327. THIS RECALL EXPANDS AND REPLACES PREVIOUS RECALL NUMBER 24V-200. VEHICLES PREVIOUSLY REPAIRED UNDER RECALL 24V-200 WILL NEED TO HAVE THE NEW REMEDY COMPLETED.

12/27/2024		Virginia Motor Vehicle Dept.	<b>Vehicle purchase reported</b>
02/23/2025	115,657	Virginia Motor Vehicle Dept. Winchester, VA	<b>Title issued or updated</b> - Vehicle repossessed
03/06/2025		Online Listing	<b>Vehicle offered for sale</b>
03/14/2025		Auto Auction	<b>Vehicle sold</b>
			Millions of used vehicles are bought and sold at auction every year.
04/08/2025	115,755	Auto Auction	<b>Vehicle sold</b>
05/08/2025		Finesse A Car Los Angeles, CA 562-360-4819 finesseacar.com ★ 2.6 / 5.0 7 Verified Reviews	<b>Vehicle offered for sale</b>
07/28/2025		CARFAX Car Care	<b>Manufacturer Recommended Maintenance Schedules</b>



Get this vehicle's maintenance schedule, service history and recall alerts at [carfax.com/service](https://www.carfax.com/service).

Have Questions? Please visit our Help Center at [www.carfax.com](https://www.carfax.com).



## Glossary

### Damage Indicator

Damage can be a result of many different types of events. Examples include contact with objects (other cars, trees, traffic signs, road debris, etc), vandalism, or weather-related events. Not every damage event is reported to CARFAX. As details about the damage event become available, those additional details are added to the CARFAX Vehicle History Report. CARFAX recommends that you have this vehicle inspected by a qualified mechanic.

- This CARFAX Vehicle History Report is based only on information supplied to CARFAX and available as of 7/28/25 at 2:49:17 PM (CDT). Other information about this vehicle, including problems, may not have been reported to CARFAX. Use this report as one important tool, along with a vehicle inspection and test drive, to make a better decision about your next used car.

### Damage Severity

Damage events result in one of the following severity levels:

- Minor: Generally, minor damage is cosmetic (including dents or scratches), may only require reconditioning, and typically does not compromise a vehicle's operation and/or safety.
- Moderate: Moderate damage may affect multiple components of the vehicle and may impair the vehicle's operation and/or safety.
- Severe: Severe damage usually affects multiple components of the vehicle and is likely to compromise the vehicle's operation and/or safety.

CARFAX recommends getting a pre-purchase inspection at a certified collision repair facility.

### First Owner

When the first owner(s) obtains a title from a Department of Motor Vehicles as proof of ownership.

### Manufacturer Recall

Automobile manufacturers issue recall notices to inform vehicle owners of a safety defect or failure to meet minimum federal safety or emissions standards. Manufacturer recalls are repaired at no cost to the customer.

### New Owner Reported

When a vehicle is sold to a new owner, the Title must be transferred to the new owner(s) at a Department of Motor Vehicles.

### Ownership History

CARFAX defines an owner as an individual or business that possesses and uses a vehicle. Not all title transactions represent changes in ownership. To provide estimated number of owners, CARFAX proprietary technology analyzes all the events in a vehicle history. Estimated ownership is available for vehicles manufactured after 1991 and titled solely in the US including Puerto Rico. Dealers sometimes opt to take ownership of a vehicle and are required to in the following states: Maine, Massachusetts, New Jersey, Ohio, Oklahoma, Pennsylvania and South Dakota. Please consider this as you review a vehicle's estimated ownership history.

### Repossession

When a repossession occurs a vehicle owner fails to make loan payments, and the financial institution holding the title takes possession of the vehicle.

### Title Issued

A state issues a title to provide a vehicle owner with proof of ownership. Each title has a unique number. Each title or registration record on a CARFAX report does not necessarily indicate a change in ownership. In Canada, a registration and bill of sale are used as proof of ownership.

Follow Us:  [facebook.com/CARFAX](https://www.facebook.com/CARFAX)

 [@CARFAXinc](https://twitter.com/CARFAXinc)

 About CARFAX

CARFAX DEPENDS ON ITS SOURCES FOR THE ACCURACY AND RELIABILITY OF ITS INFORMATION. THEREFORE, NO RESPONSIBILITY IS ASSUMED BY CARFAX OR ITS AGENTS FOR ERRORS OR OMISSIONS IN THIS REPORT. CARFAX FURTHER EXPRESSLY DISCLAIMS ALL WARRANTIES, EXPRESS OR IMPLIED, INCLUDING ANY IMPLIED WARRANTIES OF MERCHANTABILITY OR FITNESS FOR A PARTICULAR PURPOSE.

SYSTEMATIC RETRIEVAL OF THE CONTENT OR OTHER DATA FROM THIS SITE TO CREATE OR COMPILE, DIRECTLY OR INDIRECTLY, IN WHOLE OR IN PART, A COLLECTION, COMPILATION, DATABASE OR DIRECTORY WITHOUT THE EXPRESS WRITTEN PERMISSION OF CARFAX IS STRICTLY PROHIBITED. BY USING THE CARFAX VEHICLE HISTORY REPORT YOU AGREE TO THE CARFAX TERMS OF USE AND PRIVACY STATEMENT.

© 2025 CARFAX, Inc., part of S&P Global. All rights reserved.  
7/28/25 2:49:17 PM (CDT)



## Warranty Check™

CARFAX has estimated the remaining original manufacturer warranty coverage based on information reported to us on this **2022 KIA EV6 WIND (KNDC34LA4N5044738)**.

Please confirm remaining factory warranty and extended warranty options with your dealer or vehicle manufacturer.

## 2022 KIA EV6 WIND

**VIN:** KNDC34LA4N5044738

**Estimated start date of warranty:** 05/20/2022

**Last CARFAX reading reported on 04/08/2025:** 115,755 miles

**Today's date:** 07/28/2025

Type of Coverage	Original Warranty	Estimated Remaining Coverage
<b>Basic</b>	60 months or 60,000 miles	Coverage Expired
<b>Drivetrain</b>	120 months or 100,000 miles	Coverage Expired
<b>Emissions</b>	No data reported to CARFAX	
<b>Corrosion</b>	60 months or 100,000 miles	Coverage Expired
<b>Transferable</b>	No data reported to CARFAX	
<b>Roadside</b>	60 months or 60,000 miles	Coverage Expired
<b>Safety belt &amp; inflatable restraint</b>	No data reported to CARFAX	
<b>Specific Components</b>	No data reported to CARFAX	
<b>Notes</b>	Electric Vehicle System coverage: 10/100,000. Service Adjustment coverage: 1/12,000.	

**i** CARFAX Warranty Check provides an **estimate** of this vehicle's remaining warranty coverage. It does not take into account some vehicle history events such as some title brands that may void the original manufacturer warranty or ownership transfers that may decrease warranty coverage. This warranty information is only valid for vehicles manufactured for the United States. Complete warranty coverage information is available for this vehicle at the KIA website.

© 2025 CARFAX, Inc., part of S&P Global. All rights reserved.  
7/28/25 2:49:17 PM (CDT)



# CARFAX Buyback Guarantee

## CARFAX Buyback Coverage:

07/28/2025 - 07/28/2026

## CARFAX Vehicle Description:

2022 KIA EV6 WIND

**VIN:**

KNDC34LA4N5044738

**Body Style:**

4 Door Wagon/Sport Utility

**Driveline:**

Rear wheel drive

**Engine:**

### You may qualify

if you find that any of these problems were reported by a U.S. Department of Motor Vehicles and were not included in this report.



**Severe Damage:**

Salvage/Junk  
Rebuilt/Reconstructed  
Dismantled  
Fire/Flood/Hail



**Odometer Problems:**

Exceeds Mechanical Limits  
Not Actual Mileage



**Lemon History:**

Manufacturer Buyback

### Terms and Conditions Apply

[View Terms and Conditions for CARFAX Buyback Guarantee coverage](#)